

Article number: 604140022015

Description: Timing belt pulley with hub  
HTD 22 3M 15

## Measures

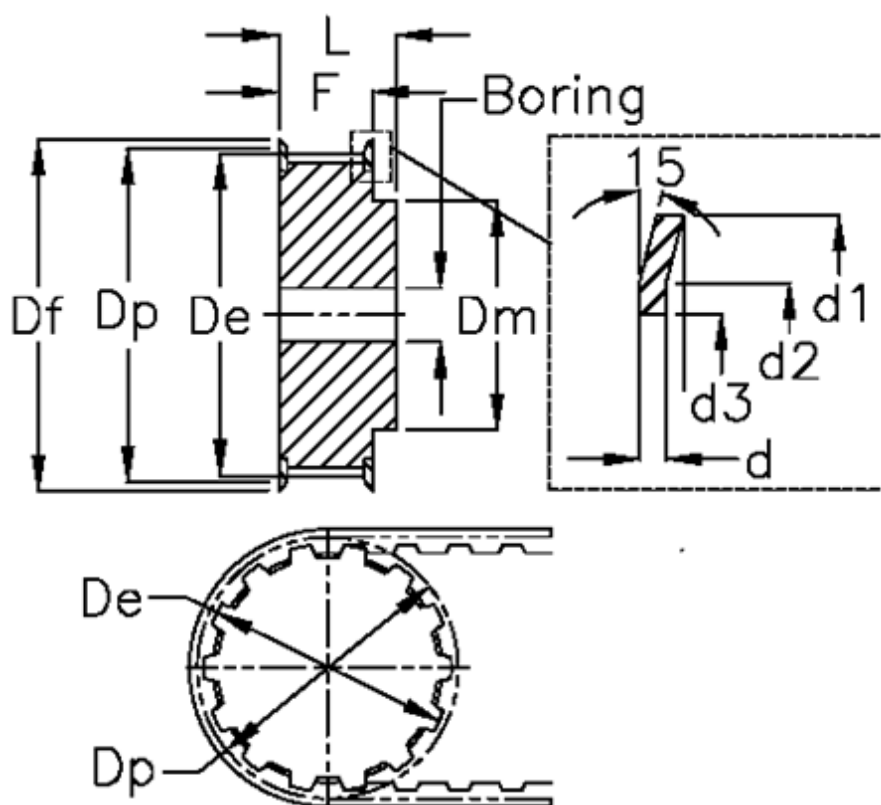

Bore = 6	Dp = 21.01
d = 0.5	F = 19.5
d1 = 25	Flange type = F08
d2 = 21.5	L = 26
d3 = 15	Tooth number = 22
De = 20.25	Type = 3M
Df = 25	Weight = 0.018
Dm = 13	Width = 15